

# UKA 35/80/35/50S

Technical data  
Version 2021/09

air connection / feet

M 1:10

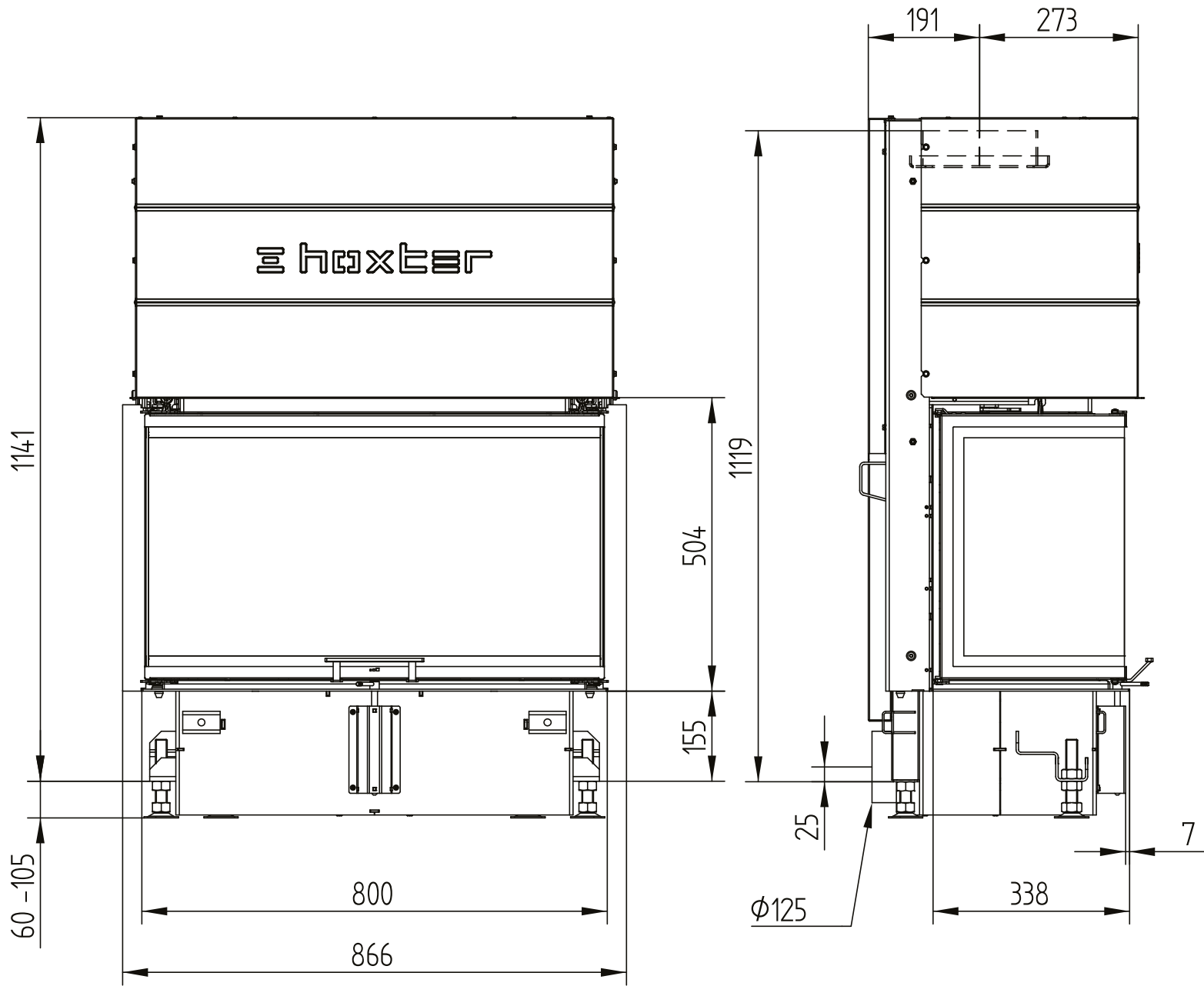

# UKA 35/80/35/50S

Technical data  
Version 2021/09

air connection / feet

M 1:10

