

# HAKA 63/51 tunnel

Technical data  
Version 2019/08

hot air exchanger 45° / air intake / feet

M 1:10

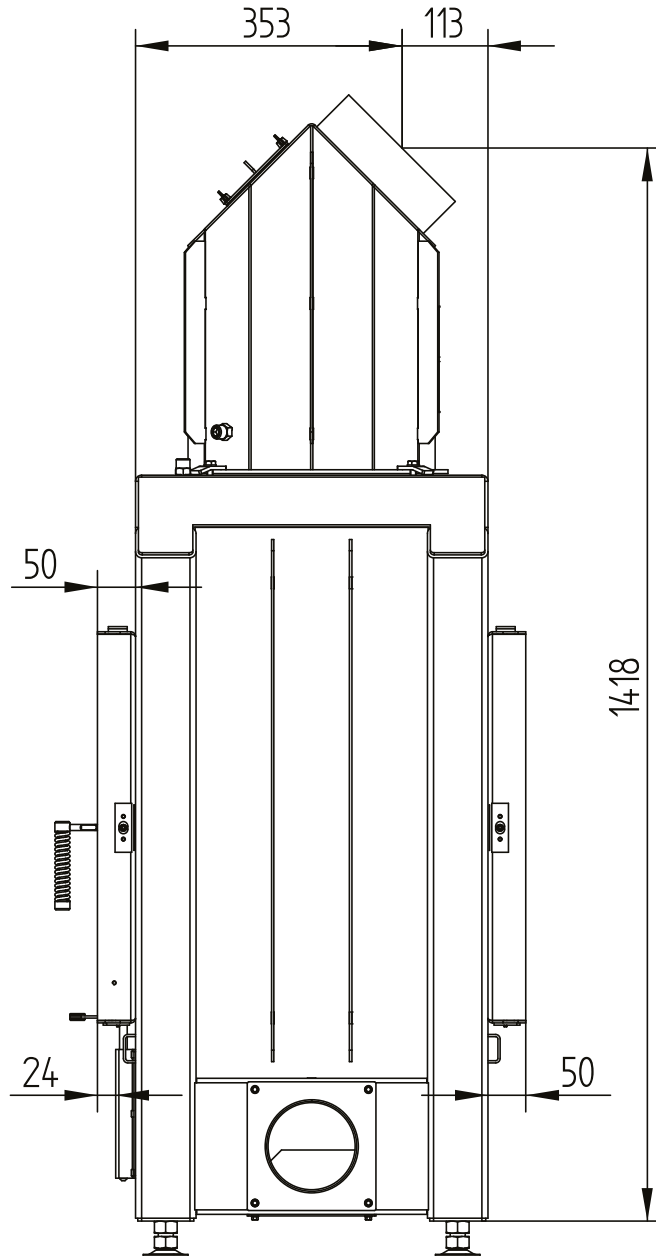

# HAKA 63/51 tunnel

Technical data  
Version 2019/08

hot air exchanger 45° / air intake / feet

M 1:10

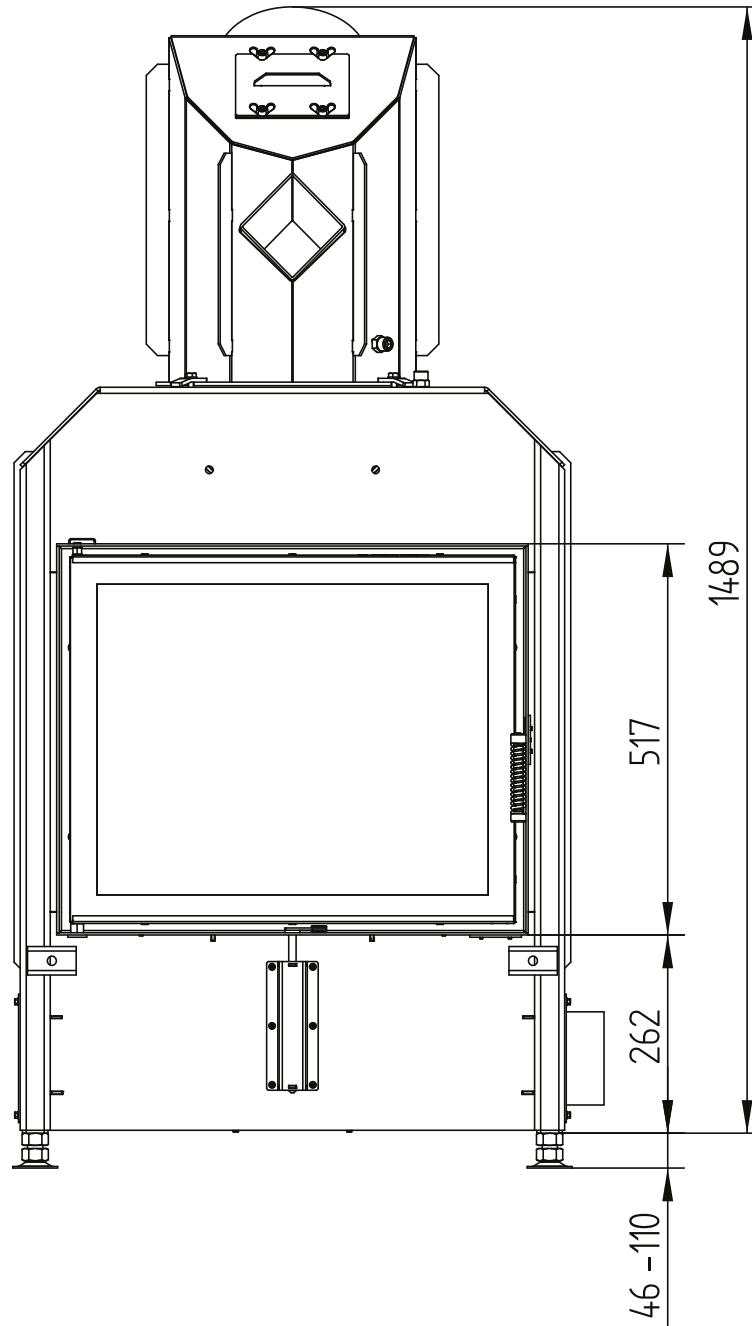

# HAKA 63/51 tunnel

Technical data  
Version 2019/08

hot air exchanger 45° / air intake / feet

M 1:10

